

COMPONENTS REQUIRED

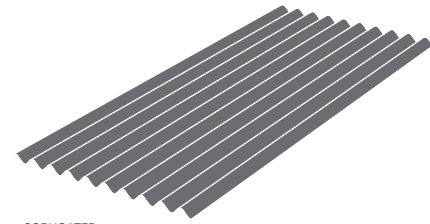

CORRUGATED BITUMEN SHEETS

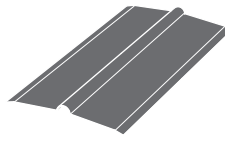

ROOF RIDGES



COLOUR-MATCHED ROOF NAILS

TOOLS REQUIRED



PROTECTIVE GLOVES



PROTECTIVE GLASSES



SPRAY LUBRICATING OIL

see TOP TIPS page 3



COARSE TOOTH HAND SAW



POWER SAW



HAMMER



TAPE MEASURE



STRAIGHT EDGE

INSTALLATION

1

MEASURE ROOF

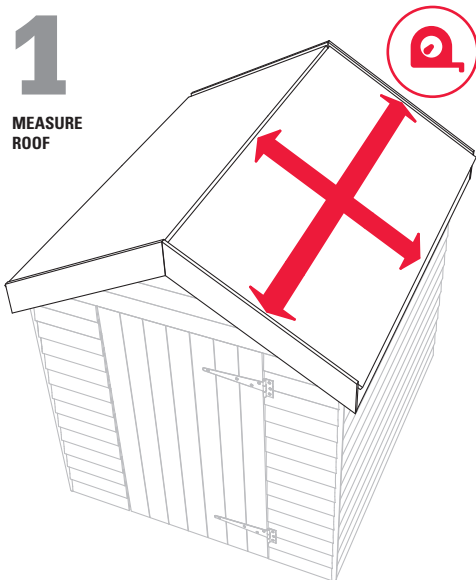

2

INSTALL FIRST CORRUGATED BITUMEN SHEET

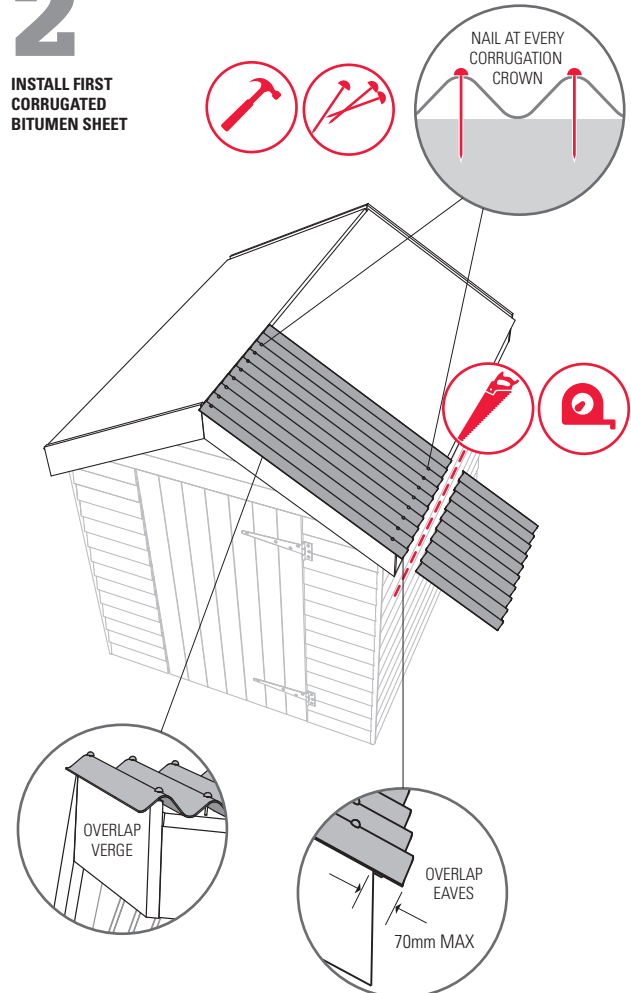

3

INSTALL SECOND CORRUGATED BITUMEN SHEET

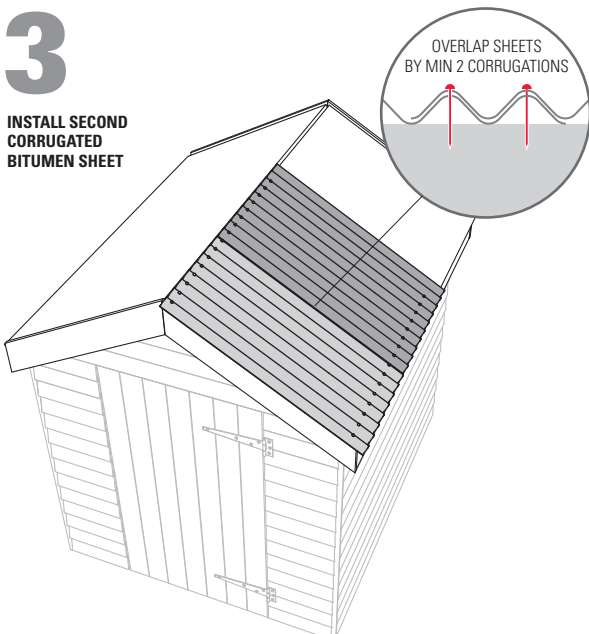

INSTALLATION

4

INSTALL FINAL CORRUGATED BITUMEN SHEET

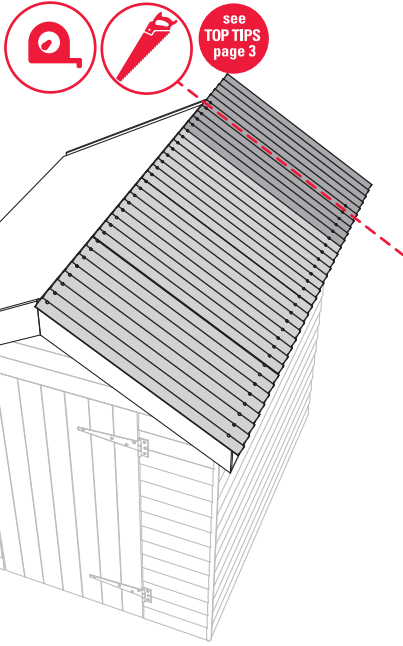

5

FOLD AND NAIL ROOF VERGES

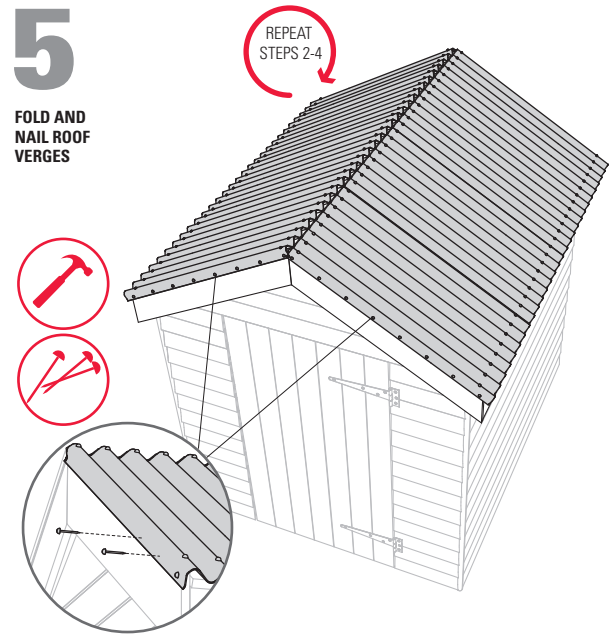

6

INSTALL ROOF RIDGES

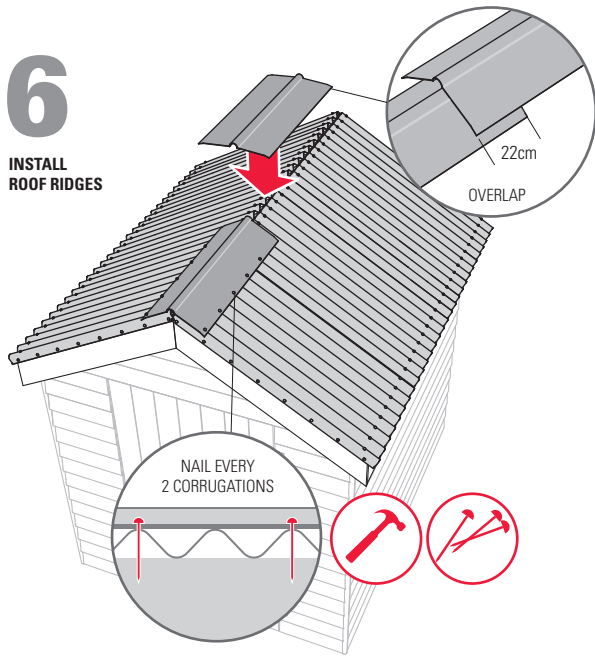

7

COMPLETE THE INSTALLATION

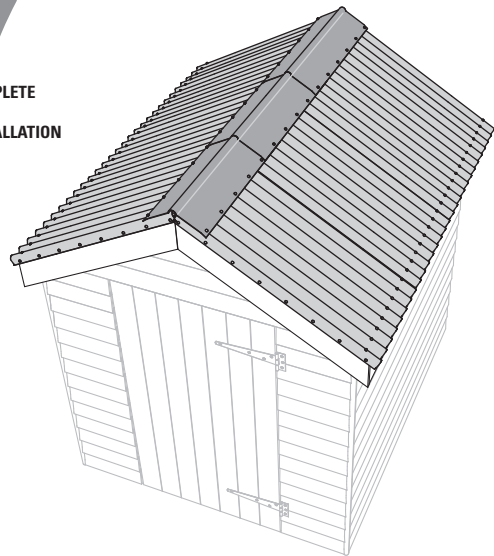

INSTALLATION ON LARGER ROOFS

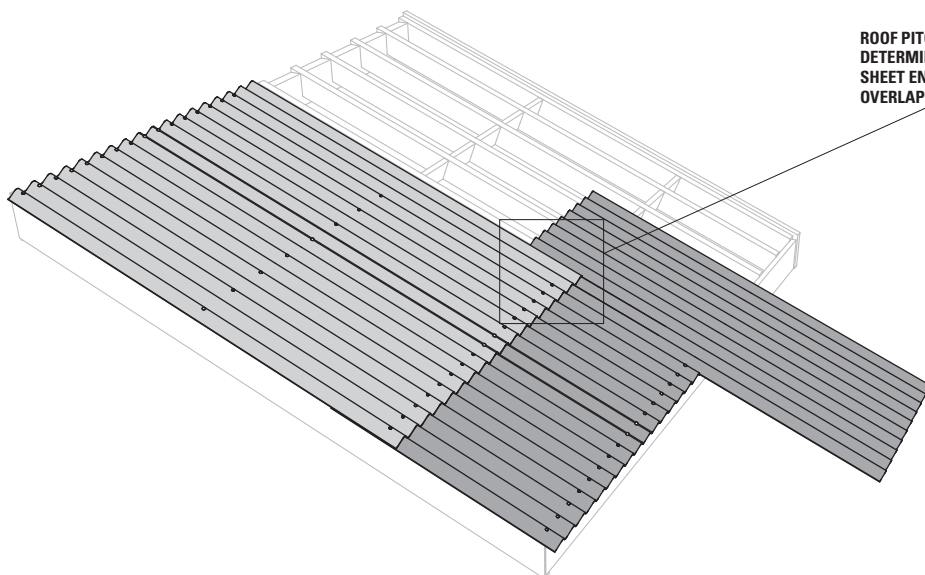

ROOF PITCH DETERMINES SHEET END OVERLAP

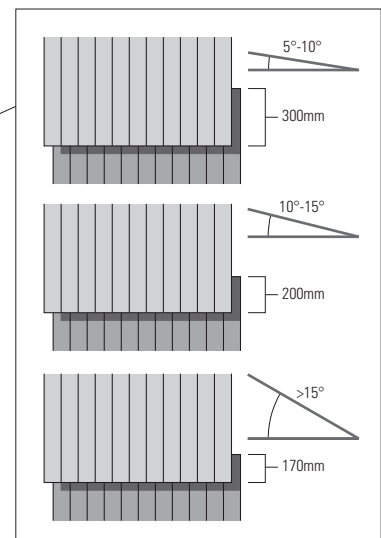

1 AVOID THE NECESSITY FOR VERTICAL CUTS BY OVERLAPPING ROOF SHEETS BY MORE THAN 2 CORRUGATIONS TO EXACTLY MATCH THE ROOF DIMENSION

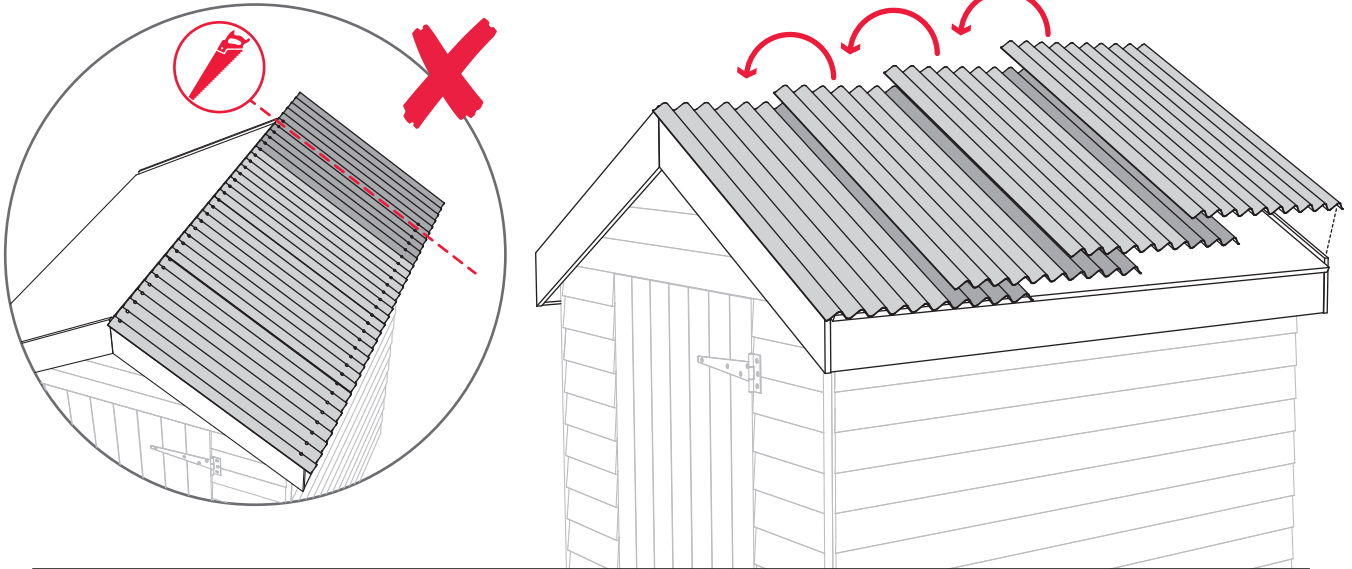

2 PRIOR TO MAKING HORIZONTAL CUTS GIVE YOUR SAW BLADE A FEW SQUIRTS OF LUBRICATING OIL - IT'LL MAKE THE JOB A LOT EASIER.

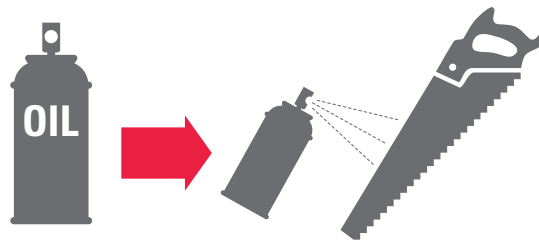

3 **IMPORTANT** - TO KEEP YOUR NEW ROOF WATERTIGHT AND WEATHERPROOF, ENSURE THAT YOU ALWAYS NAIL THE ROOF SHEETS THROUGH THE CROWN OF THE CORRUGATION, NEVER THROUGH THE GULLEY.

